

2-Line Cordless Telephone

Operating Instructions

US

DIGITAL **900** MHz

CALLER ID
with call waiting

SPP-IM982

Owner's Record

The model and the serial numbers are located at the bottom of the unit. Record the serial number in the space provided below. Refer to these numbers whenever you call upon your Sony dealer regarding this product.

Model No. SPP-IM982

Serial No. _____

IMPORTANT SAFETY INSTRUCTIONS

When using your telephone equipment, basic safety precautions should always be followed to reduce the risk of fire, electric shock and injury to persons, including the following:

1. Read and understand all instructions.
2. Follow all warnings and instructions marked on the product.
3. Unplug this product from the wall outlet before cleaning. Do not use liquid cleaners or aerosol cleaners. Use a damp cloth for cleaning.
4. Do not use this product near water, for example, near a bath tub, wash bowl, kitchen sink, or laundry tub, in a wet basement, or near a swimming pool.
5. Do not place this product on an unstable cart, stand, or table. The product may fall, causing serious damage to the product.
6. Slots and openings in the cabinet and the back or bottom are provided for ventilation. To protect it from overheating, these openings must not be blocked or covered. The openings should never be blocked by placing the product on the bed, sofa, rug, or other similar surface. This product should never be placed near or over a radiator or heat register. This product should not be placed in a built-in installation unless proper ventilation is provided.
7. This product should be operated only from the type of power source indicated on the marking label. If you are not sure of the type of power supply to your home, consult your dealer or local power company.
8. Do not allow anything to rest on the power cord. Do not locate this product where the cord will be abused by persons walking on it.
9. Do not overload wall outlets and extension cords as this can result in the risk of fire or electric shock.
10. Never push objects of any kind into this product through cabinet slots as they may touch dangerous voltage points or short out parts that could result in a risk of fire or electric shock. Never spill liquid of any kind on the product.
11. To reduce the risk of electric shock, do not disassemble this product, but take it to a qualified service personnel when some service or repair work is required. Opening or removing covers may expose you to dangerous voltages or other risks. Incorrect reassembly can cause electric shock when the appliance is subsequently used.
12. Unplug this product from the wall outlet and refer servicing to qualified service personnel under the following conditions:
 - A. When the power cord or plug is damaged or frayed.
 - B. If liquid has been spilled into the product.
 - C. If the product has been exposed to rain or water.
 - D. If the product does not operate normally by following the operating instructions. Adjust only those controls that are covered by the operating instructions because improper adjustment of other controls may result in damage and will often require extensive work by a qualified technician to restore the product to normal operation.
 - E. If the product has been dropped or the cabinet has been damaged.
 - F. If the product exhibits a distinct change in performance.

13. Avoid using a telephone (other than a cordless type) during an electrical storm. There may be a remote risk of electric shock from lightning.
14. Do not use the telephone to report a gas leak in the vicinity of the leak.

SAVE THESE INSTRUCTIONS

CAUTION:

To reduce the risk of fire or injury to persons by battery, read and follow these instructions.

1. Use only the following type and size battery pack: Sony BP-T23.
2. Do not dispose of the battery pack in a fire. The cell may explode. Check with local codes for possible special disposal instructions.
3. Do not open or mutilate the battery pack. Released electrolyte is corrosive and may cause damage to the eyes or skin. It may be toxic if swallowed.
4. Exercise care in handling battery pack in order not to short the battery with conducting materials such as rings, bracelets, and keys. The battery or conductor may overheat and cause burns.
5. Charge the battery pack provided with or identified for use with this product only in accordance with the instructions and limitations specified in the instruction manual provided for this product.
6. Observe proper polarity orientation between the battery pack and battery charger.

INFORMATION FOR GENERAL TELEPHONES

1. This equipment complies with Part 68 of the FCC rules. On the bottom of this equipment is a label that contains, among other information, the FCC certification number and ringer equivalence number (REN) for this equipment. If requested, this information must be provided to the telephone company.
2. The applicable certification jack (connector) USOC-RJ11C/W, RJ14C/W are used for this equipment.

3. This equipment is designed to be connected to the telephone network or premises wiring using a compatible modular jack that is Part 68 compliant.

The FCC compliant telephone cord and modular plug is provided with this equipment.

4. The REN is used to determine the quantity of devices that may be connected to the telephone line. Excessive RENs on the telephone line may result in the devices not ringing in response to an incoming call. Typically, the sum of the RENs should not exceed five (5.0). To be certain of the number of devices that may be connected to a line, as determined by the total RENs, contact the local telephone company.
5. If this equipment (SPP-IM982) causes harm to the telephone network, the telephone company will notify you in advance that temporary discontinuance of service may be required. But if advance notice isn't practical, the telephone company will notify the customer as soon as possible. Also, you will be advised of your right to file a complaint with the FCC if you believe it is necessary.
6. The telephone company may make changes in its facilities, equipment, operations or procedures that could affect the operation of the equipment. If this happens the telephone company will provide advance notice so you can make necessary modifications to maintain uninterrupted service.
7. If trouble is experienced with this equipment (SPP-IM982), for repair or warranty information, please contact Sony Direct Response Center: Tel 1-800-222-7669. If the equipment is causing harm to the telephone network, the telephone company may request that you disconnect the equipment until the problem is resolved.
8. All repairs will be performed in an authorized Sony service station.
9. This equipment cannot be used to party lines or coin lines.
10. This equipment is hearing aid compatible.

If your telephone is equipped with automatic dialers

When programming emergency numbers and (or) making test calls to emergency numbers:

1. Remain on the line and briefly explain to the dispatcher the reason for the call.
2. Perform such activities in the off-peak hours, such as early morning or late evenings.

Caution

You are cautioned that any changes or modifications not expressly approved in this manual could void your authority to operate this equipment.

Note

This equipment has been tested and found to comply with the limits for a Class B digital device, pursuant to Part 15 of the FCC Rules. These limits are designed to provide reasonable protection against harmful interference in a residential installation. This equipment generates, uses and can radiate radio frequency energy and, if not installed and used in accordance with the instructions, may cause harmful interference to radio communications. However, there is no guarantee that interference will not occur in a particular installation. If this equipment does cause harmful interference to radio or television reception, which can be determined by turning the equipment off and on, the user is encouraged to try to correct the interference by one or more of the following measures:

- Reorient or relocate the receiving antenna.
- Increase the separation between the equipment and receiver.
- Connect the equipment into an outlet on a circuit different from that to which the receiver is connected.
- Consult the dealer or an experienced radio/TV technician for help.

Table of contents

Getting Started

- 8 Read this first
 - 9 Step 1: Checking the package contents
 - 10 Step 2: Setting up the base unit
 - 14 Step 3: Preparing the battery pack
 - 17 Step 4: Entering the area code
 - 20 Identifying the parts
-

Basics

- 24 Making calls
 - 26 Redialing
 - 27 Making another call while talking
 - 28 Receiving calls
 - 31 Receiving a call while talking
-

Telephone Features

- 32 Phone Directory
 - 32 Storing phone numbers and names
 - 34 Changing a stored name and/or phone number
 - 35 Erasing a memory location
 - 35 Making calls from the Phone Directory
- 37 Setting the ringer type
 - 38 Turning off the ringer of the handset
- 39 Switching the phones during a call
 - 39 To switch from the base unit to the handset

- 39 To switch from the handset to the base unit
- 40 Talking between the phones (Intercom)
 - 40 To talk from the handset to the base unit
 - 40 To talk from the base unit to the handset
- 41 Receiving a call while using the intercom
- 42 Transferring a call
 - 42 To transfer from the base unit to the handset
 - 43 To transfer from the handset to the base unit
- 44 Having a conference call
 - 44 Making another call while talking
 - 45 Receiving a call while talking
 - 46 Switching conference from the handset to the base unit
 - 46 Switching conference from the base unit to the handset
 - 46 To join on the base unit while the handset is talking on one line
 - 46 To join on the handset while the base unit is talking on one line
 - 46 To join three-way conference (four-way conference)

Caller ID Features

- 47 Understanding the Caller ID service
 - 47 When you receive a call
- 48 Looking at the Caller ID list
 - 48 Viewing the Caller ID list
 - 49 Erasing data from the Caller ID list

-
- 51 Using the Caller ID list
 - 51 Calling back a number from the Caller ID list
 - 52 Storing a number of the Caller ID list into the Phone Directory
 - 53 To change the number of digits of the phone number
 - 55 Using “Caller ID with call waiting” service
 - 56 Using visual message waiting service

Additional Information

- 58 Mounting the base unit on a wall
- 59 Carrying the handset by the belt clip
- 60 Notes on power sources
- 61 Maintenance
- 62 Troubleshooting
- 65 Specifications
- 66 Index

Back cover LIMITED WARRANTY

Read this first

Before you use your phone, you must first set it up. Here's a quick way to set up your phone: Steps 1, 2, 3 and 4.

Step 1 (page 9)

First, unpack the phone and the supplied accessories.

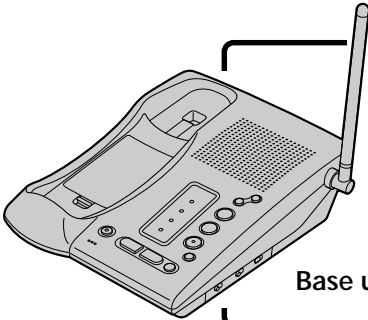

Base unit

Step 2 (pages 10 to 13)

Next, you need to do three things to set up the base unit, including finding the best location for the base unit.



Handset

Step 3 (pages 14 to 15)

Then, insert the battery pack into the handset and charge it for more than 12 hours.

Step 4 (pages 17 to 19)

Finally, enter the area code to use the Caller ID service.

That's it!

Step 1

Checking the package contents

Make sure you have received the following items in the package.
If anything is missing, contact your local Sony dealer.

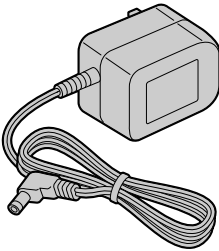

AC power adaptor (AC-T128)

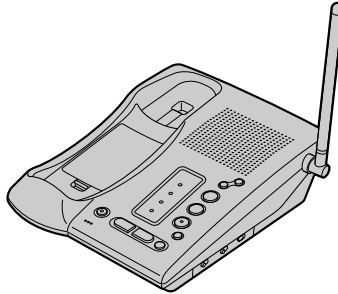

Base unit

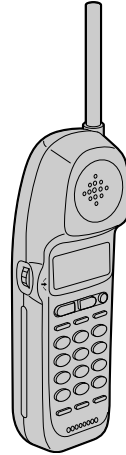

Handset

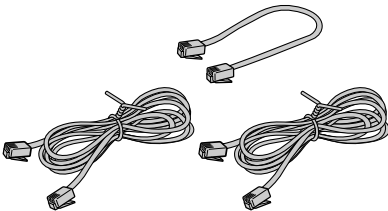

Telephone line cords (3)

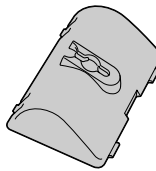

Wall bracket for
base unit

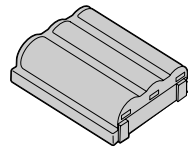

Rechargeable battery
pack (BP-T23)

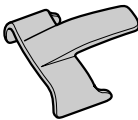

Belt clip

Step 2

Setting up the base unit

Do the following steps:

- Choose the best location
- Connect the base unit
- Choose the dialing mode

Choose the best location

Where you place the base unit affects the reception quality of the handset.

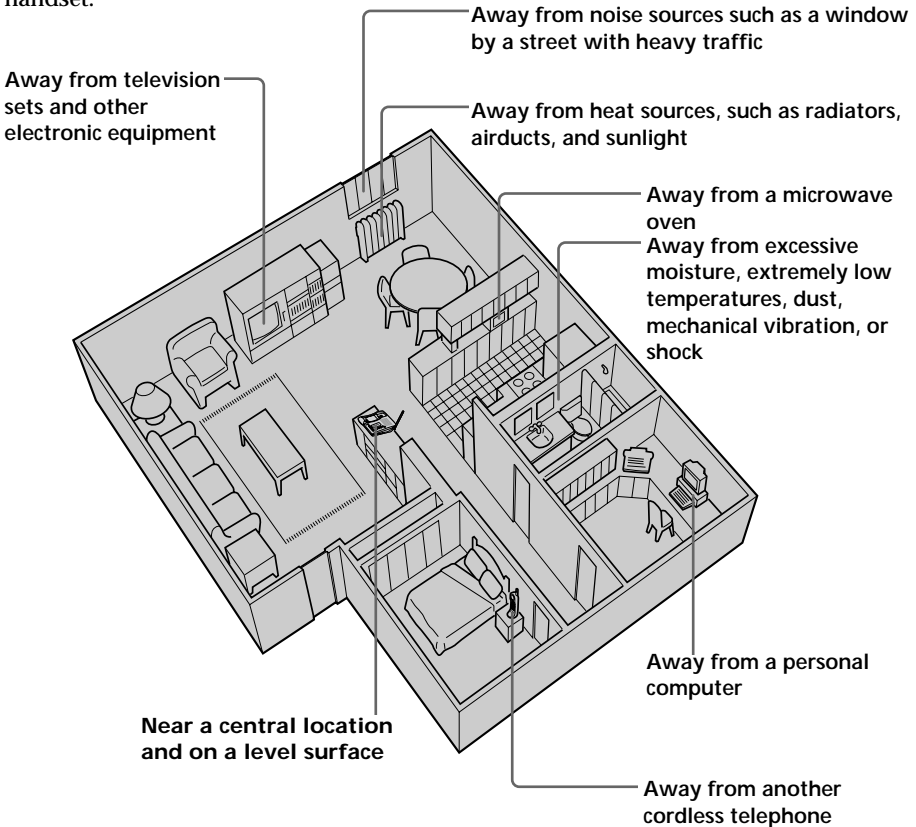

- CAUTION:**
- Should you experience intermittent loss of audio during a conversation, try moving closer to the base or move base unit away from other noise sources.
 - The cordless telephone operates at a frequency that may cause interference to nearby TVs and VCRs; the base unit should not be placed near or on the top of a TV or VCR; and, if interference is experienced, moving the cordless telephone farther away from the TV or VCR will often reduce or eliminate the interference.

Connect the base unit

If you want to hang the base unit on the wall, see page 58.

To connect the base unit to a single outlet having two lines

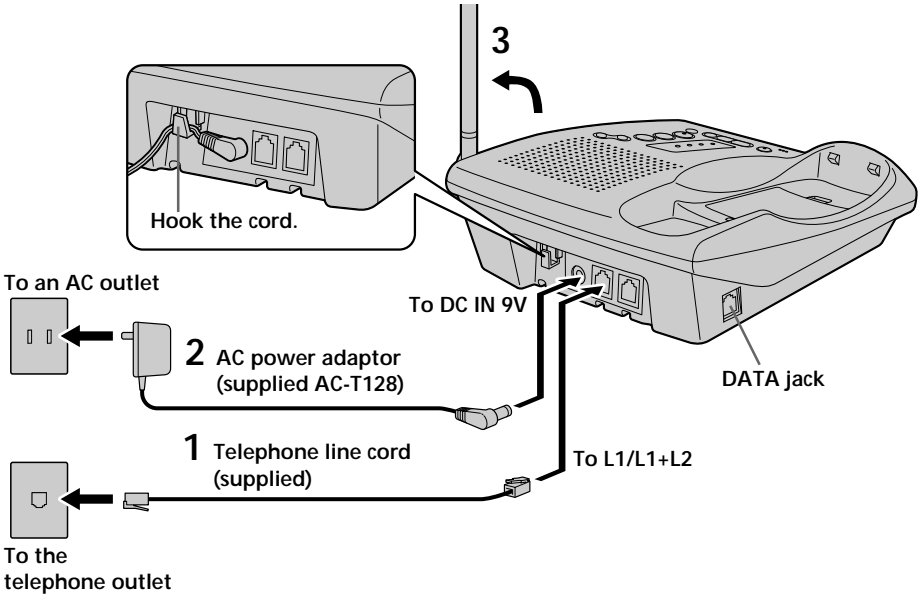

- 1** Connect the telephone line cord to the L1/L1+L2 jack and to a telephone outlet.
- 2** Connect the AC power adaptor to the DC IN 9V jack and to an AC outlet.
- 3** Raise the antenna. Make sure it points towards the ceiling.

continued

Step 2: Setting up the base unit (continued)

To connect the base unit to two separate outlets

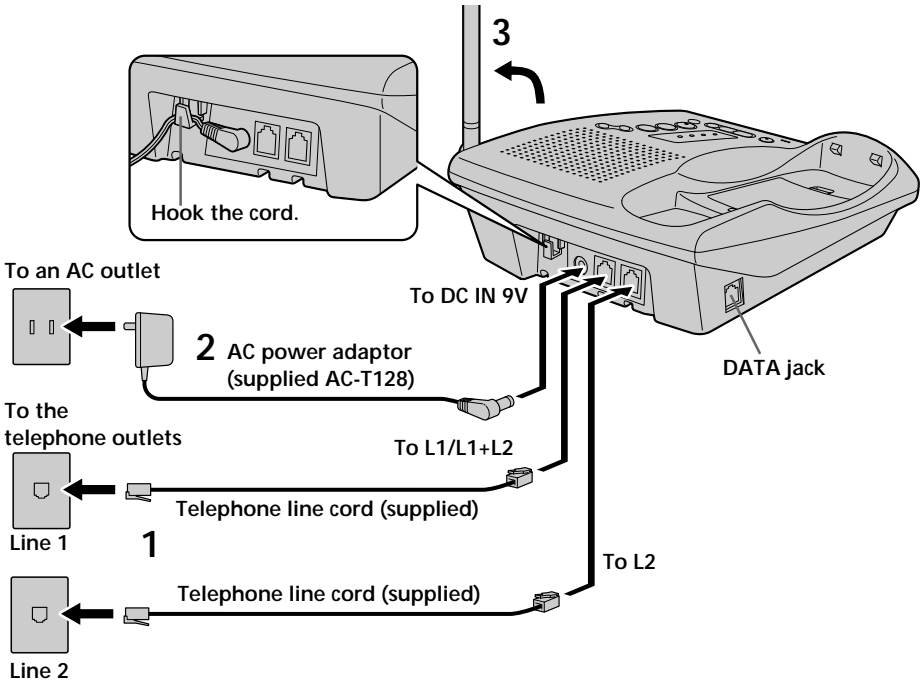

- 1** Connect the telephone line cords to the L1/L1+L2 and L2 jacks and to the telephone outlets.
- 2** Connect the AC power adaptor to the DC IN 9V jack and to an AC outlet.
- 3** Raise the antenna. Make sure it points towards the ceiling.

Notes

- Use only the supplied AC-T128 AC power adaptor. Do not use any other AC power adaptor.
- Connect the AC power adaptor to a continuous power supply.
- Place the base unit close to the AC outlet so that you can unplug the AC power adaptor easily.

Tips

- If your telephone outlet is not modular, contact your telephone service company for assistance.
- L1 is the first phone line connected to center pair of wires. L2 is the second phone line connected to outer pair of wires.

Connecting a computer or FAX

You can connect a computer or FAX, etc. to the DATA jack.

Notes

- L2 jack is used for receiving or sending computer or FAX data in addition to making or receiving calls.

If a call comes in on L2 jack with the “call waiting” service while a computer or FAX connected to the DATA jack is receiving or sending data, that data may be effected.

If you have data communication frequently, we recommend that you and your callers use L2 jack for data communication only.

- If you have only single outlet having one line, connect the telephone line cord to the L2 jack.

Polarity of the plug



Modular

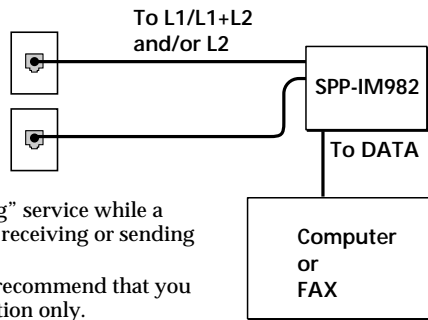
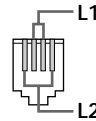

Choose the dialing mode

For the telephone to work properly, select an appropriate dialing mode (tone or pulse).

Depending on your dialing system, set the DIAL MODE switch as follows:

If your dialing system is	Set the switch to
Tone	TONE
Pulse	PULSE

If you aren't sure of your dialing system

Make a trial call with the DIAL MODE switch set to TONE.

If the call connects, leave the switch as is; otherwise, set to PULSE.

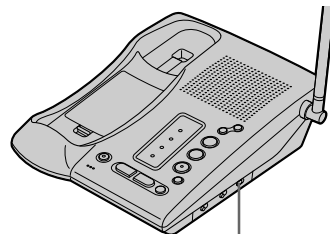

DIAL MODE switch

Step 3

Preparing the battery pack

Charge the battery pack for more than 12 hours before you start using your phone.

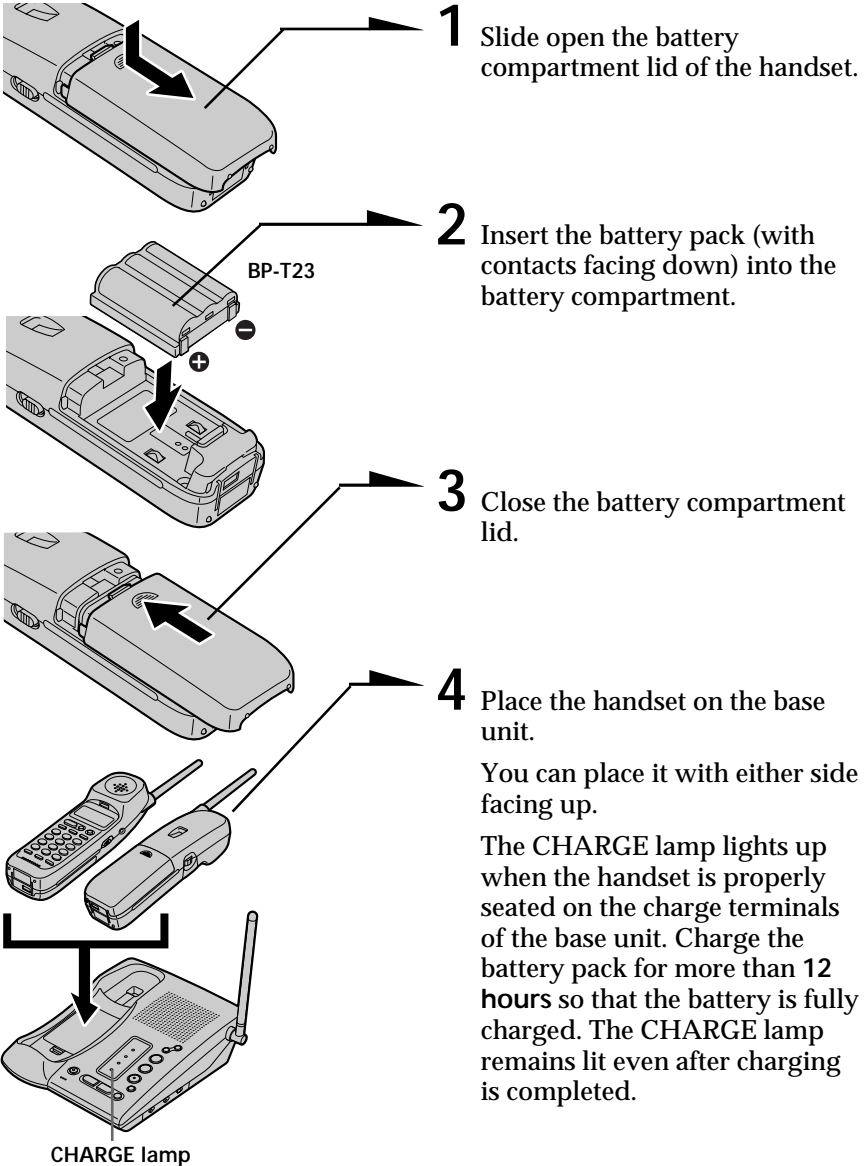

Battery duration

A fully charged battery pack lasts for about:

- Approx. 7 hours when you use the handset continuously
- Approx. 7 days when the handset is in standby mode.

Notes

- The battery pack will gradually discharge over a long period of time, even when not in use.
- If you leave the battery pack in the handset without charging it, the battery pack will be completely discharged.
It may require several times of charging to recover to its full capacity.

To obtain the best performance from the battery

Do not place the handset on the base unit after each call. The battery works best if the handset is returned to the base unit after two or three calls. However, do not leave the handset off the base unit for a long period of time as this will completely discharge the battery pack.

When to purchase a new battery pack

If the battery lasts only a few minutes even after **12 hours** of charging, the usable life of the battery has expired and needs replacement. Contact your local Sony authorized dealer or service center, and ask for a Sony BP-T23 rechargeable battery pack.

Note

Battery life may vary depending on usage condition and ambient temperature.

continued

Step 3: Preparing the battery pack (continued)

Handset spare battery usage

As only one battery pack is supplied with this unit, it is necessary to purchase an additional battery pack (optional) for use as a handset spare battery pack.

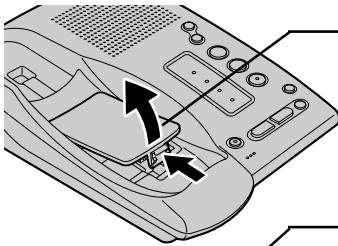

1 Open the battery compartment lid of the base unit.

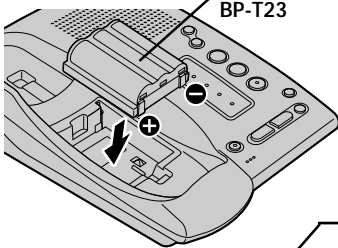

2 Insert the battery pack (with contacts facing down) into the battery compartment.

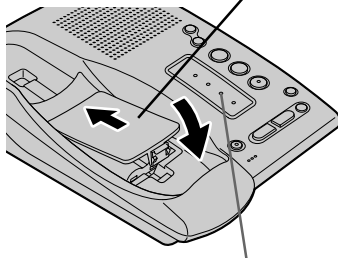

3 Close the battery compartment lid.

The SPARE BATT lamp lights up. Charge the battery pack for more than 24 hours so that the battery is fully charged. The SPARE BATT lamp remains lit even after charging is completed.

Step 4

Entering the area code

When you use this phone for the first time, or move to an area that has a different area code, you must enter your home area code. Otherwise, you cannot use some functions of this phone and the Caller ID functions.

This is also necessary because the phone must be able to select an area code to properly dial call from the Caller ID list.

Depending on your region, enter 3-digit area code as follows:

Case 1.

If 7-digit dialing (no area code) is accepted for local calls in your area, see “To enter your home area code” below.

If you live in an area where calls from or to other local areas can also be made by 10-digit dialing (area code + number), you can register up to 5 local area codes with this telephone to take advantage of this system. See “To enter the local area code (For 10 digits phone number users)” on page 18.

Case 2.

If 10-digit dialing (area code + number) is required for all local calls in your area, at first, enter “000” in your home area code. See “To enter your home area code” below. Then see “To enter the local area code (For 10 digits phone number users)” on page 18.

To enter your home area code

1 Press **PGM**.

2 Turn Jog Dial up to make “AREA” flash.

3 Press Jog Dial.

4 Press Jog Dial again. “ENTER AREA CODE” appears on the display.

continued

Step 4: Entering the area code (continued)

5 Enter three digits of your home area code using the dialing keys.

6 Press **(PGM)**.

You will hear a long confirmation beep.

Notes

- If the home area code is already entered, it appears on the display in step 4. To enter a different home area code, see “To change the home area code” below.
- Do not allow more than 20 seconds to elapse between each step of the procedure.

Tips

- You may press Jog Dial instead of **(PGM)** in step 6.
- To check the current home area code, perform steps 1 to 4. The home area code appears on the display for about 20 seconds.

To change the home area code

1 Perform steps 1 to 4 on page 17.

The current home area code appears on the display.

2 Turn Jog Dial down to erase the current home area code.

3 Enter a new home area code using the dialing keys.

4 Press **(PGM)**.

You will hear a long confirmation beep.

To enter the local area code (For 10 digits phone numbers users)

If a call matches one of the local area codes you entered, the phone number will be registered with 10 digits in the Caller ID list (area code + number). If a call does not match one of the local area codes you entered, the phone number will be registered with 11 digits in the Caller ID list (1 + area code + number). Some regions of the country allow you to have more than one local area code. (Up to five local area codes can be entered in this phone.)

1 Perform steps 1 to 3 on page 17.

2 Turn Jog Dial up to make “LOCAL” flash.



3 Press Jog Dial.

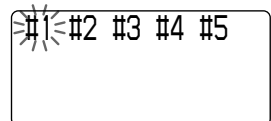

- 4** Select the number ("#1" to "#5") to enter the local area code by turning Jog Dial.
- 5** Press Jog Dial.
"ENTER AREA CODE" appears on the display.
- 6** Enter three digits of the local area code using the dialing keys.
- 7** Press **(PGM)**.
You will hear a long confirmation beep.

Notes

- If the local area code is already entered, it appears on the display in step 5. To enter a different local area code, see "To change the local area code" below.
- Do not allow more than 20 seconds to elapse between each step of the procedure.

Tips

- You may press Jog Dial instead of **(PGM)** in step 7.
- To check the current local area code, perform steps 1 to 5. The local area code appears on the display for about 20 seconds.

To change the local area code

- 1** Perform steps 1 to 5 on pages 18 to 19.
The current local area code appears on the display.
- 2** Turn Jog Dial down to erase the current local area code.
- 3** Enter a new local area code using the dialing keys.
- 4** Press **(PGM)**.
You will hear a long confirmation beep.

To erase the local area code

You can erase the local area code. Perform steps 1 and 2 above, then press **(PGM)**.

The local area code will be erased, and you will hear a long confirmation beep.

Identifying the parts

Refer to the pages indicated in parentheses for details.

Base Unit

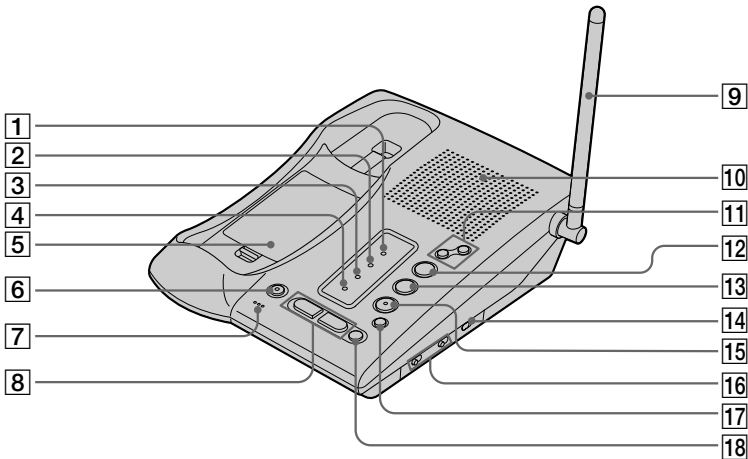

- 1 NEW CALL lamp** (p. 48)
Flashes when there is a “NEW” data in the Caller ID list.
- 2 MESSAGES lamp** (p. 56)
Flashes when you have messages.
- 3 SPARE BATT lamp** (p. 16)
Lights while the spare battery is being charged.
- 4 CHARGE lamp** (p. 14)
Lights while the battery is being charged.
- 5 Battery compartment** (p. 16)
- 6 MUTING button** (p. 30)
Mutes your voice during a conversation.
- 7 MIC (microphone)**
- 8 LINE buttons (1, 2)** (p. 29)
Lets you receive a call.
- 9 Antenna** (p. 11, 58)
- 10 Speaker**
- 11 VOL +/- buttons** (p. 30)
Adjusts the speaker volume.
- 12 HOLD button** (p. 30)
Puts a call on hold.
- 13 CONF (conference) button** (p. 44)
Lets you talk with two parties at the same time.
- 14 DIAL MODE switch** (p. 13)
Selects pulse or tone dialing.
- 15 INTERCOM button** (p. 40)
Lets you talk between the base unit and handset.
- 16 RINGER LEVEL switches (L1, L2)** (p. 30)
Adjusts the ringer volume.
- 17 CALL WAITING/FLASH button** (p. 30)
Switches to a second call if you have “call waiting” service, or lets you make a new call.

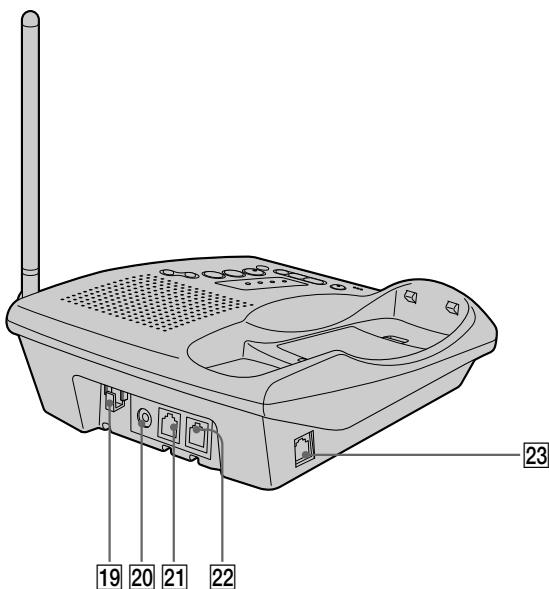

- 18** OFF button (p. 29)
Allows you to disconnect the call.
- 19** Hook for AC power adaptor cord (p. 11)
- 20** DC IN 9V jack (p. 11, 58)
- 21** L1/L1+L2 jack (p. 11, 58)
- 22** L2 jack (p. 12, 58)
- 23** DATA jack (p. 13)

continued

Identifying the parts (continued)

Handset

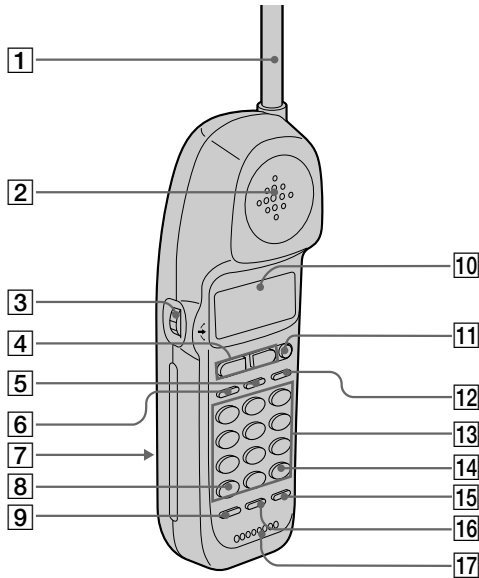

1 Antenna

2 Speaker

3 Jog Dial (p. 17, 32, 48)

4 LINE buttons (1, 2) (p. 24, 28)

Lets you make or receive a call.

5 INTERCOM button (p. 40)

Lets you talk between the base unit and handset.

6 HOLD button (p. 25)

Puts a call on hold.

7 Battery compartment (p. 14)

8 * TONE button (p. 25)

Allows you to switch temporarily to tone dialing.

9 CONF (conference) button (p. 44)

Lets you talk with two parties at the same time.

10 Display window (p. 24, 47)

11 OFF button (p. 24)

Allows you to disconnect the call.

12 FLASH/CALL WAITING button (p. 25, 55)

Switches to a second call if you have "call waiting" service, or lets you make a new call.

13 Dialing keys (p. 24)

14 # button (p. 53)

Used to change the number of digits of the phone number in the Caller ID list.

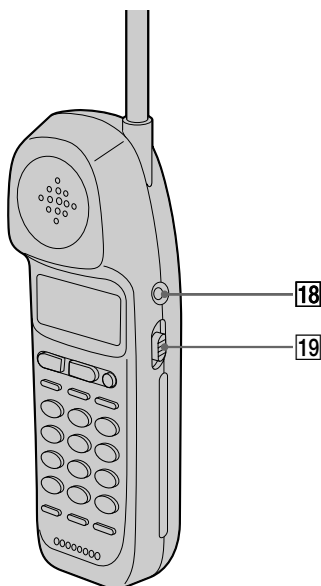

- 15 REDIAL/PAUSE button**
(p. 26, 33)
Redials the last number called/
inserts a pause in the dialing
sequence.
- 16 PGM (program) button**
(p. 17, 32)
Used to store numbers in Phone
Directory.
- 17 Microphone**
- 18**  (HEADSET) jack (p. 24, 28, 59)
- 19 VOL (volume) switch** (p. 25)
Adjusts the handset volume.

Making calls

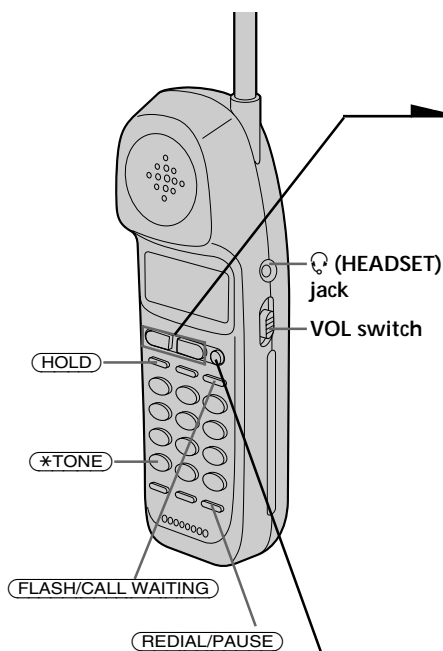

1 Pick up the handset from the base unit.

2 Press **LINE 1** or **LINE 2** to select the line.

The corresponding line button lights up.

“TALK” appears on the display and the display also shows the talk time in hours, minutes and seconds.

You will then hear a dial tone.

The line button on the base unit double flashes in succession.

If “CHANNEL SEARCHING...” appears on the display, move closer to the base unit.

3 Dial the phone number.

4 When you’re done talking, press **OFF** or replace the handset on the base unit.

The display and the LINE 1 or LINE 2 button go off.

Making calls when the headset is connected

When the TL-HD1 headset (optional) is connected to the (HEADSET) jack, you can talk through the headset.

Precaution

Avoid listening your headset at so loud a volume that extended play might affect your hearing.

Additional tasks

To	Do this
Adjust the handset volume	Set the VOL switch to H (high), M (middle) or L (low).
Put a call on hold	Press (HOLD) . The LINE 1 or LINE 2 button will flash slowly. Press (LINE 1) or (LINE 2) to resume the conversation.
Switch to tone dialing temporarily	Press (*TONE) after you're connected. The line will remain in tone dialing until disconnected.
Switch to another call ("call waiting" service*)	Press (FLASH/CALL WAITING) . Press (FLASH/CALL WAITING) again to return to the first caller.

* You need to subscribe to the service from your telephone company.

Notes

- When you increase the sound volume, in some cases the back ground noise may be increased as well. You should adjust the volume accordingly.
- If your conversation is muted and "CHANNEL SEARCHING..." appears on the display, move closer to the base unit; otherwise, the call will be disconnected after one minute.

Tips

- If you pick up another phone connected to the same phone line, the hold will be automatically released and you will be able to resume conversation on that phone.
- The LINE 1 or LINE 2 button on the handset double flashes in succession, when the base unit is used. If you press **(LINE 1)** or **(LINE 2)** whichever button is flashing, you can talk to the base unit and to the line connected.

If the battery becomes weak during a call

The handset will beep every three seconds five times and  and "BATTERY LOW" appears on the display. Finish your call and charge the battery pack.

For optimum performance, charge the battery for a full 12 hours.

Note that during the first 10 - 15 minutes of charging, the phone will be inactive, i.e., unable to make or receive a call.

After this initial 10 - 15 minutes, you **may** be able to use the phone, but the battery duration will be **very short**; thus it is recommended that you **fully charge** the battery before the next usage.

continued

Making calls (continued)

If you have a spare battery

You can replace the battery pack without disconnecting the call during a conversation. To replace the battery pack, perform the following procedure.

- 1 Press **(HOLD)** on the handset.
The call is on hold and “HOLD” appears on the display.
- 2 Replace the battery pack.
- 3 Press **(LINE 1)** or **(LINE 2)** to resume the conversation.

Redialing

- 1 Press **(LINE 1)** or **(LINE 2)** to select the line.
The corresponding line button lights up.
- 2 Press **(REDIAL/PAUSE)** to redial the last number dialed.

Note

If the number exceeds 32 digits or if it is erased, five short error beeps will alert you that the number cannot be redialed.

To check the phone number before redialing

While the handset is not in use, press **(REDIAL/PAUSE)**.

The last number dialed is displayed for five seconds.

To dial the number, press **(LINE 1)** or **(LINE 2)** while the number is displayed.

Note

The number will not be displayed if the last number dialed exceeds 32 digits or if it is erased.

To erase the last phone number dialed

While the handset is not in use, press **(REDIAL/PAUSE)** twice within five seconds.

The number will be erased from the memory, and you will hear a long confirmation beep.

Making another call while talking

Example: Making a call on line 2 while talking on line 1

1 Press **(HOLD)** while talking.

The line 1 is put on hold and the LINE 1 button flashes slowly.

2 Press **(LINE 2)**.

3 Dial a phone number for the second party.

Now you can talk to the second party on line 2.

4 To put on hold line 2 and resume the conversation on line 1, press **(HOLD)**, and then **(LINE 1)**.

or

To disconnect line 2 and resume the conversation on line 1, press **(LINE 1)**.

Note

If you do not press **(HOLD)** in step 1, line 1 will be disconnected.

You can talk with two parties at the same time using both line 1 and line 2, see “Having a conference call” on page 44.

Receiving calls

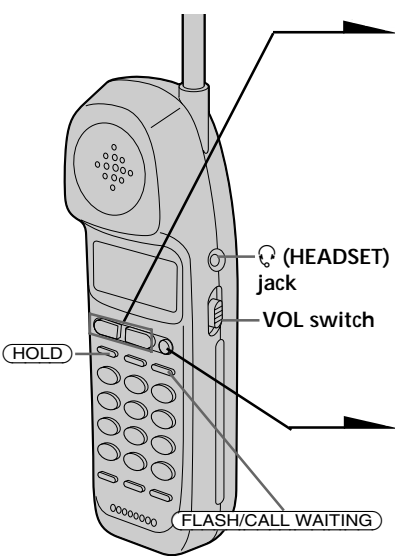

1 When you hear the phone ring, press **LINE 1** or **LINE 2** whichever button is flashing.

The corresponding line button lights up.

“TALK” appears on the display and the display also shows the talk time in hours, minutes and seconds.

The line button on the base unit double flashes in succession.

2 When you're done talking, press **OFF** or replace the handset on the base unit.

The display and the LINE 1 or LINE 2 button go off.

Receiving calls when the headset is connected

When the TL-HD1 headset (optional) is connected to the (HEADSET) jack, you can talk through the headset.

Precaution

Avoid listening your headset at so loud a volume that extended play might affect your hearing.

Additional tasks

To	Do this
Adjust the handset volume	Set the VOL switch to H (high), M (middle) or L (low).
Put a call on hold	Press (HOLD) . The LINE 1 or LINE 2 button will flash slowly. Press (LINE 1) or (LINE 2) to resume the conversation.
Switch to another call (“call waiting” service*)	Press (FLASH/CALL WAITING) . Press (FLASH/CALL WAITING) again to return to the first caller.
Turn on/off the ringer of the handset	See “Turning off the ringer of the handset” on page 38.

* You need to subscribe to the service from your telephone company.

Note

If another call comes in by “call waiting” service while conversing with an outside caller, you will hear two short beeps.

Tip

To inform you of an incoming call, the display shows “** RINGING **” when ringing.

If you have subscribed to the Caller ID service;

- the caller’s number and/or name appears on the display when you receive a call (see page 47) or when another call comes in by “call waiting” service.
- the ringer sound changes to a higher tone if the call matches the number stored in the Phone Directory (memory match function; see page 47).

Receiving calls through the speakerphone

When you hear the phone ring, press **(LINE 1)** or **(LINE 2)** whichever button is flashing.

The corresponding line button lights up.

When you’re done talking, press **(OFF)**.

To obtain the best speakerphone performance, see page 30.

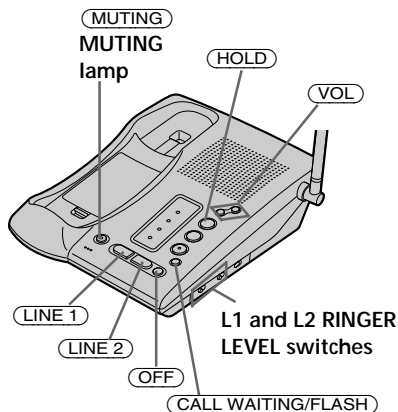

continued

Receiving calls (continued)

Additional tasks

To	Do this
Adjust the speaker volume	During speakerphone conversation, press (VOL) (+) or (-). Each press of (VOL) (+) or (-) switches the speaker volume by one of 8 levels.
Adjust the ringer volume of the base unit	You can adjust the ringer volume of line 1 and 2 respectively. Set the L1 or L2 RINGER LEVEL switch on the base unit to HIGH, LOW or OFF.
Put a call on hold	Press (HOLD). The LINE 1 or LINE 2 button will flash slowly. Press (LINE 1) or (LINE 2) to resume the conversation.
Mute your voice	Press (MUTING) to disable the microphone. The MUTING lamp lights up. Press (MUTING) again to cancel.
Switch to another call ("call waiting" service*)	Press (CALL WAITING/FLASH). Press (CALL WAITING/FLASH) again to return to the first caller.

* You need to subscribe to the service from your telephone company.

Note

Even when you set the L1 or L2 RINGER LEVEL switch on the base unit to OFF, the handset will ring when the ringer of the handset is turned on (see page 38).

Tips

- To inform you of an incoming call, the line button lights on and off according to the ring signal even when you set the L1 or L2 RINGER LEVEL switch on the base unit to OFF.
- If there is an incoming call while on the intercom, the base unit will ring at a low level even when the L1 or L2 RINGER LEVEL switch on the base unit is set to OFF.

To obtain the best speakerphone performance

- You may not be able to hear the other party's voice in a noisy place. Therefore, use the speakerphone in a quiet room.
- Do not bring your hand or other object too close to the microphone or you will hear a shrill noise ("feedback").
- When the speaker volume is loud, or the base unit has been placed close to a wall, you may find that the volume drops suddenly. This is due to a circuit in the telephone designed to protect against feedback. In such cases, lower the speaker volume slightly.

Receiving a call while talking

If another call comes in while talking on the other line, the corresponding line button will flash.

Example: Receiving a call on line 2 while talking on line 1

1 Press **(HOLD)** while talking.

The line 1 is put on hold and the LINE 1 button flashes slowly.

2 Press **(LINE 2)**.

Now you can talk to another caller on line 2.

3 To put on hold line 2 and resume the conversation on line 1, press **(HOLD)**, and then **(LINE 1)**.

or

To disconnect line 2 and resume the conversation on line 1, press **(LINE 1)**.

Notes

- If you do not press **(HOLD)** in step 1, line 1 will be disconnected.
- If another call comes in while talking on the base unit, a beep will be heard through the base unit and the corresponding line button on the base unit will flash.
- If another call comes in while talking on the handset, a ringer tone will be heard once through the handset and the corresponding line button on the handset will flash. At this time, the base unit will ring and the corresponding line button will flash normally.

You can talk with two parties at the same time using both line 1 and line 2, see “Having a conference call” on page 44.

Phone Directory

You can dial a number by scrolling through the Phone Directory, in which up to 50 phone numbers can be stored.

Storing phone numbers and names

Example: to store “SONY” “123-4567”.

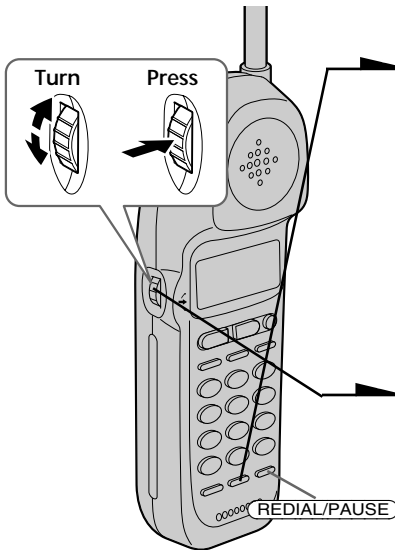

- 1 Press (PGM).
(Be sure not to press (LINE 1) and (LINE 2).)



If “DIRECTORY” is not flashing, turn Jog Dial down to make it flash.

- 2 Press Jog Dial.
“ENTER NAME” appears.

- 3 Enter the name using the dialing keys.
You can enter up to 16 characters.

Press a dialing key until the desired character appears. (See the character table for details.)

Enter successive characters in the same way.

To enter two characters assigned to the same key, or to enter a “space”, turn Jog Dial up to move the cursor to the right.

Example: to enter “SONY”, press (7) four times (S), press (6) three times (O), turn Jog Dial up to move the cursor, press (6) twice (N), and press (9) three times (Y).



Character table

Key	Character
①	1
②	A → B → C → 2
③	D → E → F → 3
④	G → H → I → 4
⑤	J → K → L → 5
⑥	M → N → O → 6
⑦	P → Q → R → S → 7
⑧	T → U → V → 8
⑨	W → X → Y → Z → 9
⑩	0
*	*
#	& → ' → , → - → . → #

4 Press **(PGM)**.

“ENTER NUMBER” appears.

5 Enter the phone number.

You can enter up to 32 digits, including a tone and a pause, each of which is counted as one digit.

When the phone number of 17 digits or more has been entered, the phone number appears in two lines.

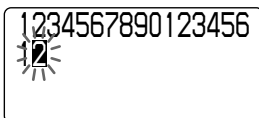
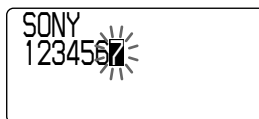

6 Press **(PGM)**.

You will hear a long confirmation beep, and the name and the number are stored. The display goes off.

Notes

- If you intend to save a 51st phone number, you will hear five short error beeps and “MEMORY FULL” will be displayed. You cannot store the phone number. To store another phone number, erase one of the stored phone numbers (see page 35).
- Do not allow more than 20 seconds to elapse between each step of the procedure.
- The total number of phone numbers which can be stored into the Phone Directory varies according to the number of digits of each phone number. If all the phone numbers consist of up to 16 digits, you can store up to 50 phone numbers. However, as the Phone Directory uses two-phone number memory to store one phone number of 17 digits or more, the total number of phone numbers which can be stored in the Phone Directory decreases two by two every time you store a phone number of 17 digits or more.

Tips

- If you have entered a wrong name or number in step 3 or 5, turn Jog Dial down to erase it. Then enter the correct name or number.
- You may press Jog Dial instead of **(PGM)** in steps 4 and 6.

To store a number to be dialed via Private Branch Exchange (PBX)

Before entering a phone number in step 5 above, do as follows:

1 Enter the outside line access digit (e.g., 9).

2 Press **(REDIAL/PAUSE)**.

continued

Phone Directory (continued)

Changing a stored name and/or phone number

- 1 Display the name and phone number you want to change by doing steps 1 and 2 in “Making calls from the Phone Directory” on page 35.



- 2 Press Jog Dial.

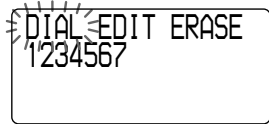

- 3 Turn Jog Dial up to make “EDIT” flash and press Jog Dial.

The cursor flashes at the last character of the name.

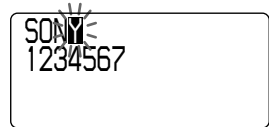

- 4 Turn Jog Dial down to erase the characters and enter the new name.

If you want to change only the number, skip this step.

- 5 Press Jog Dial.

The cursor flashes at the last digit of the phone number.

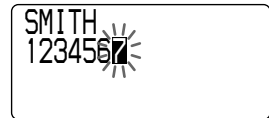

- 6 Turn Jog Dial down to erase the number and enter the new number.

If you don't want to change the number, skip this step.

- 7 Press Jog Dial.

You will hear a long confirmation beep and the name and/or the number is changed.

Tip

When the phone number of 17 digits or more has been entered, “-” is displayed next to 15th digit and then the all digits are displayed in two lines after about two seconds.

Erasing a memory location

1 Display the name and phone number you want to erase by doing steps 1 and 2 in “Making calls from the Phone Directory”.

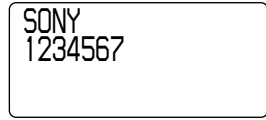

2 Press Jog Dial.

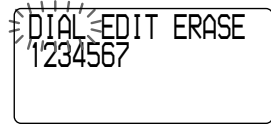

3 Turn Jog Dial up to make “ERASE” flash and press Jog Dial.

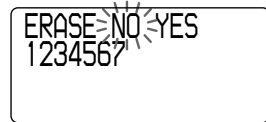

4 Turn Jog Dial up to make “YES” flash, then press Jog Dial.

You hear a long confirmation beep and the memory location is erased.

Making calls from the Phone Directory

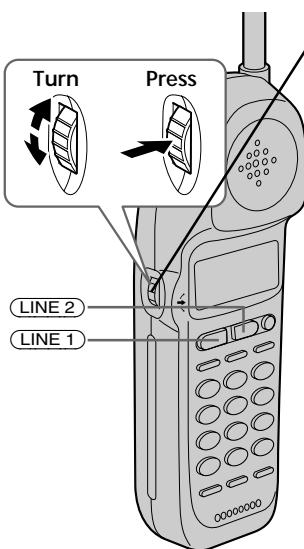

1 Press Jog Dial.
“DIRECTORY” appears on the display.

2 Display the name and phone number you want to call.
To search in alphabetical order: Turn Jog Dial up or down.
To search by entering the initial character: Press the dialing key of the desired character, then turn Jog Dial.

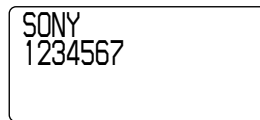

3 Press Jog Dial.

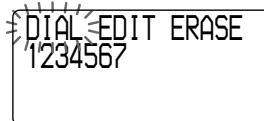

4 Press Jog Dial again.
The phone number will be dialed.

continued

Phone Directory (continued)

Tips

- You may press **LINE 1** or **LINE 2** to make a call instead of doing steps 3 and 4.
- When you press Jog Dial in step 4, the vacant line is automatically connected. When neither line is in use, line 1 is connected.

About the search order

The names appear in the following order when you turn Jog Dial up or down.

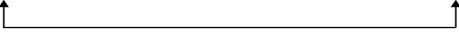
- Alphabetical order: ABC...XYZ ↔ symbols ↔ * ↔ # ↔ 0 - 9

- Initial character: To search for “SONY” for example, press **7** and then turn Jog Dial to search through the names starting with P, Q, R, S or 7.

Setting the ringer type

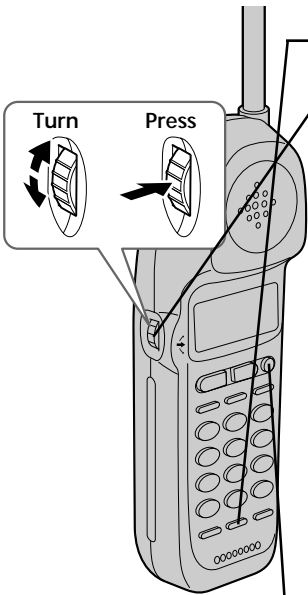
You can select a ringer type of the handset from four type.



1 Press **(PGM)**.

2 Turn Jog Dial up to make “RINGER” flash.



3 Press Jog Dial.

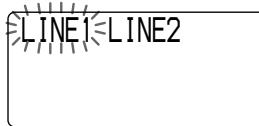

4 Turn Jog Dial to choose the line you want to set the ringer type.

5 Press Jog Dial.

The current ringer type appears.

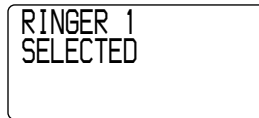

6 Press one of the dialing keys (**(1)** to **(4)**) to select a ringer type.

You will hear the corresponding ringer tone.

7 Press **(OFF)**.

Setting the ringer type (continued)

Turning off the ringer of the handset

- 1 Perform steps 1 to 5 on page 37.
- 2 Press **0**.
You will hear a confirmation beep.
- 3 Press **OFF**.



RINGER OFF
SELECTED

When “RINGER” is set to “RINGER OFF”

The handset won't ring. You can still make calls, and also receive calls if another telephone connected to the same line rings to inform you on incoming calls.

To turn the ringer on again

Follow the instructions described in “Setting the ringer type” on page 37.

Switching the phones during a call

You can easily switch between the handset and speakerphone on the base unit without disconnecting the call. The call on line 1 will be switched to line 1 on another phone and that on line 2 is switched to line 2.

To switch from the base unit to the handset

Example: While talking on line 1:

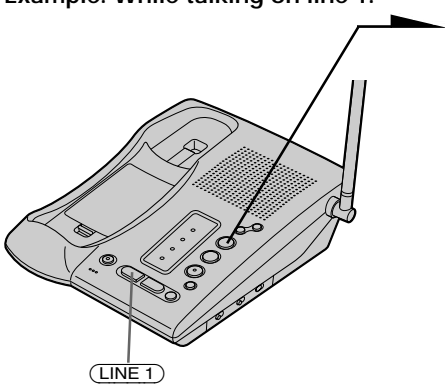

- 1 Press **HOLD** on the base unit. The call is on hold and “HOLD” appears on the display of the handset and the LINE 1 button flashes slowly.
- 2 Press **LINE 1** on the handset. The LINE 1 button on the handset lights up and the LINE 1 button on the base unit double flashes in succession.

You can continue talking to the caller through the handset.

To switch from the handset to the base unit

Example: While talking on line 1:

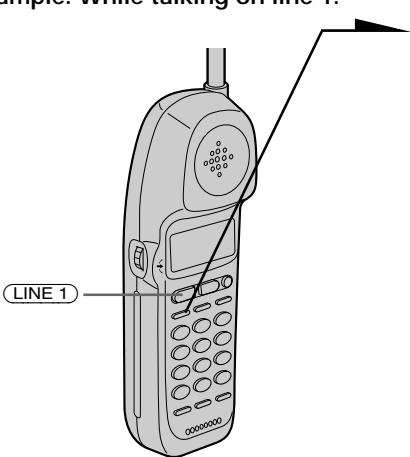

- 1 Press **HOLD** on the handset. The call is on hold and “HOLD” appears on the display of the handset and the LINE 1 button flashes slowly.
- 2 Press **LINE 1** on the base unit. The LINE 1 button on the base unit lights up and the LINE 1 button on the handset double flashes in succession.

You can continue talking to the caller through the speakerphone.

Tip

While talking through the speakerphone on the base unit (or handset), if you press **LINE 1** or **LINE 2** which is flashing on the handset (or base unit), you can talk to the base unit (or handset) and to the line connected.

Talking between the phones (Intercom)

You can converse using the base unit and the handset. You can start the intercom from either phone.

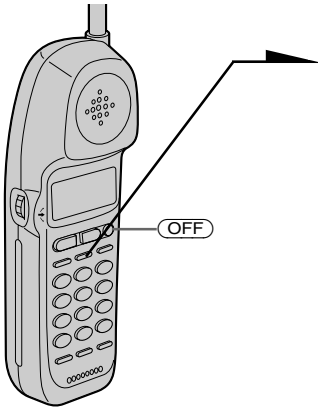

To talk from the handset to the base unit

Press **INTERCOM** on the handset.

After the base unit rings twice, you will be connected automatically.

When a person at the base unit answers, you can talk with each other.

“INTERCOM” appears on the display of the handset and the INTERCOM lamp on the base unit lights up.

When you are done talking or if no one answers the phone

Press **OFF** on the handset.

To talk from the base unit to the handset

Press **INTERCOM** on the base unit.

The base unit and handset ring and “** PAGING **” appears on the display of the handset.

When a person at the handset presses **INTERCOM**, you can talk with each other.

“INTERCOM” appears on the display of the handset and the INTERCOM lamp on the base unit lights up.

When you are done talking or if no one answers the phone

Press **OFF** on the base unit.

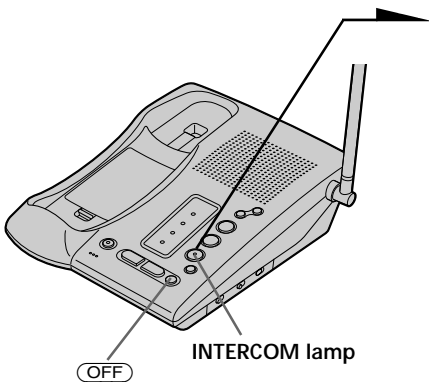

Note

While conversing with an outside caller via the base unit or handset, you cannot make an intercom call. If you press **INTERCOM**, you will hear a busy tone.

Tips

- You can receive an intercom call on the handset even when “RINGER” is set to “RINGER OFF”.
- You can receive an intercom call on the base unit even when the L1 or L2 RINGER LEVEL switch on the base unit is set to OFF. The base unit will ring at a low level.

Receiving a call while using the intercom

When a call comes in, “** RINGING **” appears on the display of the handset and only the base unit rings at a low level.

The LINE 1 or LINE 2 button flashes.

Press **LINE 1** or **LINE 2** whichever is flashing, then you can answer the call.

Transferring a call

You can transfer a call between the handset and base unit without disconnecting the call.

To transfer from the base unit to the handset

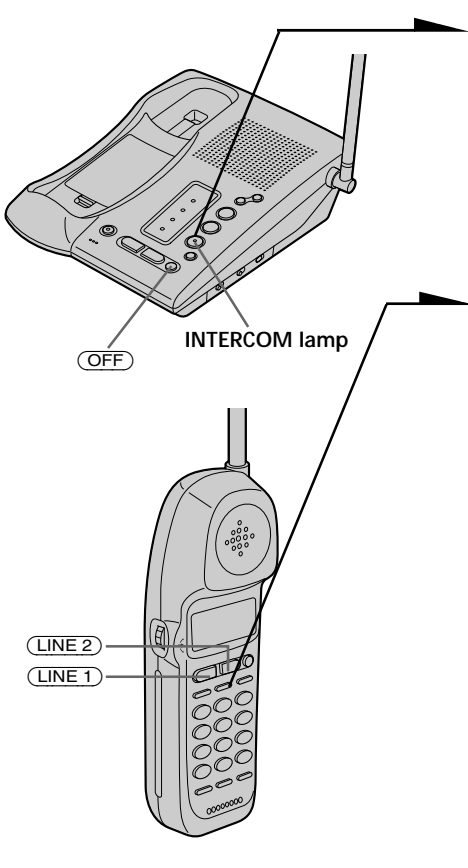

The diagram illustrates the process of transferring a call from the base unit to the handset. It shows two views: the base unit at the top and the handset at the bottom. Arrows point from the handset to the base unit for step 1, and from the base unit to the handset for step 2. Labels include 'OFF', 'INTERCOM lamp', 'LINE 2', and 'LINE 1'.

- 1** Press **INTERCOM** to page the handset.
The call is put on hold on the base unit and the handset rings. “** PAGING **” appears on the display of the handset.
- 2** Press **INTERCOM** on the handset.
“INTERCOM” appears on the display of the handset and the INTERCOM lamp on the base unit lights up.
You can talk between the base unit and the handset.
- 3** Press **LINE 1** or **LINE 2** which is flashing on the handset to talk to the caller with the handset.
“TALK” appears on the display of the handset.

If no one answers the phone
Press **OFF** on the base unit.

Tips

- You can receive an intercom call on the handset even when “RINGER” is set to “RINGER OFF”.
- If you have accidentally pressed **HOLD** in step 1, just press **INTERCOM** and you will get the same result as by pressing **INTERCOM** only.

To transfer from the handset to the base unit

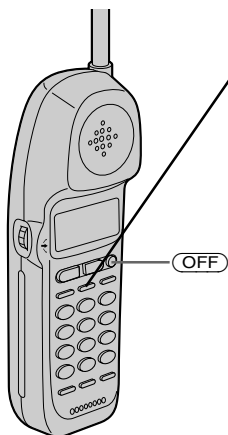

- 1** Press **INTERCOM** to page the base unit.

The call is put on hold on the handset.

After the base unit rings twice, you will be connected automatically.

When a person at the base unit answers, you can talk with each other.

“INTERCOM” appears on the display of the handset and the INTERCOM lamp on the base unit lights up.

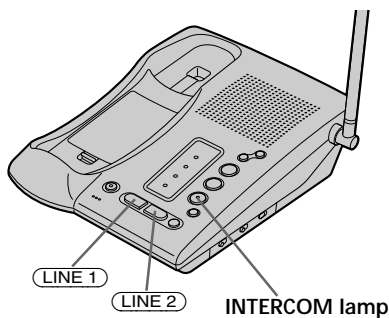

- 2** Press **LINE 1** or **LINE 2** which is flashing on the base unit to talk to the caller with the base unit.

The corresponding line button of the base unit lights up.

If no one answers the phone
Press **OFF** on the handset.

Tip

You can receive an intercom call on the base unit even when the L1 or L2 RINGER LEVEL switch on the base unit is set to OFF. The base unit will ring at a low level.

Having a conference call

You can talk on two lines at the same time and you can also talk on one line, the handset and the base unit at the same time.

Making another call while talking

You can talk with two parties at the same time using both line 1 and line 2. (Three-way conference)

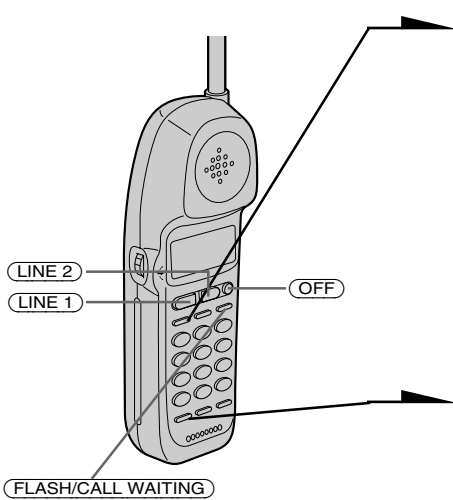

1 Press **(HOLD)** while talking on one line.

The line in use is put on hold.

2 Press **(LINE 1)** or **(LINE 2)**, whichever is not used.

3 Dial a phone number for the second party.

4 Press **(CONF)** (conference) after the second party is connected. "CONFERENCE" appears on the display.

Now you can talk to both parties.

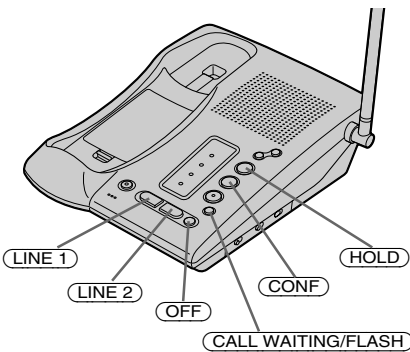

Receiving a call while talking

If another call comes in while talking, the LINE 1 or LINE 2 button on which another call is coming will flash.

1 Press **(HOLD)**.

The line in use is put on hold.

2 Press **(LINE 1)** or **(LINE 2)**, on which another call is coming.

3 Press **(CONF)** (conference).

Now you can talk to both parties. (Three-way conference)

Note

If you do not press **(HOLD)** in step 1, the first line will be disconnected.

To disconnect the lines during a three-way conference

To disconnect both lines at the same time, press **(OFF)**.

To disconnect line 1 and talk on line 2 only:

Press **(LINE 2)**.

To disconnect line 2 and talk on line 1 only:

Press **(LINE 1)**.

To put the lines on hold during a three-way conference

Press **(HOLD)**. Both lines are put on hold.

To resume the conversations on both lines:

Press **(CONF)**.

To resume the conversation only on one line:

Press **(LINE 1)** or **(LINE 2)**, for the line you want. (The other line is kept on hold.)

Tip

During a three-way conference, you cannot use “call waiting” service even if you press **(FLASH/CALL WAITING)** or **(CALL WAITING/FLASH)**.

continued

Having a conference call (continued)

Switching conference from the handset to the base unit

- 1 Press **(HOLD)** on the handset to put both lines on hold.
The LINE 1 and LINE 2 buttons on the handset and the base unit flash.
- 2 Press **(CONF)** on the base unit to resume the conversation.

Switching conference from the base unit to the handset

- 1 Press **(HOLD)** on the base unit to put both lines on hold.
The LINE 1 and LINE 2 buttons on the base unit and the handset flash.
- 2 Press **(CONF)** on the handset to resume the conversation.

To join on the base unit while the handset is talking on one line

Press the double flashing **(LINE 1)** or **(LINE 2)** on the base unit.
Now you can talk to the handset and to the line connected.

To join on the handset while the base unit is talking on one line

Press the double flashing **(LINE 1)** or **(LINE 2)** on the handset.
Now you can talk to the base unit and to the line connected.

To join three-way conference (four-way conference)

Press **(LINE 1)** or **(LINE 2)**.

Understanding the Caller ID service

Caller ID allows the caller's phone number to be shown on the display before the call is answered. In order to use this feature, you must first subscribe to the Caller ID service. The name of this service may vary depending on your telephone company.

To use this feature, be sure to enter your home area code (see page 17).

When you receive a call

The phone number appears on the display with the date and time as shown in the following example.

If your Caller ID service includes the caller name service, the caller's name also appears on the display (up to 15 letters).

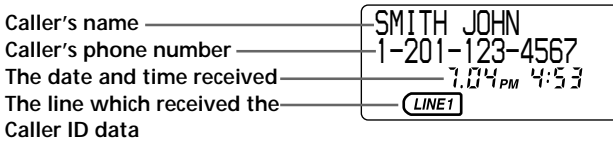

When you answer the call, the Caller ID display changes to the "TALK" display.

Notes

- The caller's phone number and/or name will not appear in the following cases:
 - "OUT OF AREA": when the call is made through a telephone company which does not offer Caller ID service (including international calls).
 - "PRIVATE": when the call is "blocked." For privacy reasons, many states allow callers the option to prevent his or her telephone data from being displayed on the other party's Caller ID display.
- If the call is from an office which uses multiple lines, the displayed phone number may not match the number you use to call the extension.

Tips

- Even if the ringer of the handset is set to "RINGER OFF", you can receive Caller ID data.
- If a call comes in on both line 1 and 2 simultaneously, the display will show the data on line 1 and 2 alternately.

About the memory match function

If you receive a call from a phone number which is stored in the Phone Directory (see page 32), the ringer sound will change to a higher tone from the second ring.

Note

The memory match function does not work with "OUT OF AREA" or "PRIVATE" calls; and it may not work with calls made from an office which uses multiple lines because the number does not always match the one you stored in this phone.

Looking at the Caller ID list

The phone stores the data of the last 20 calls received including “OUT OF AREA” and “PRIVATE” calls. It keeps track of all calls received; even if they were not answered.

Viewing the Caller ID list

You can look through the Caller ID list to check the phone number and/or name of the calls received.

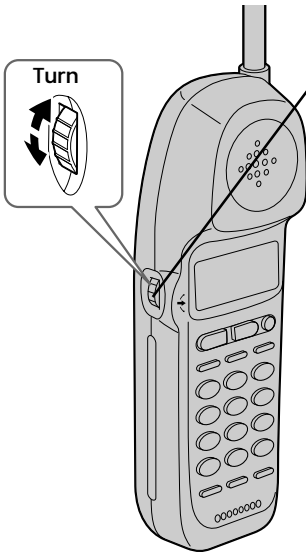

1 Turn Jog Dial.

The display shows the number of “NEW” (calls which you have not viewed) and “OLD” (calls which you have viewed) calls.

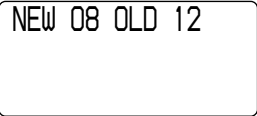

2 Turn Jog Dial down to display older data or up to display newer data.

Note

If a 21st call is received, the oldest data is automatically erased.

Tip

If there is a “NEW” data, the NEW CALL lamp of the base unit flashes.

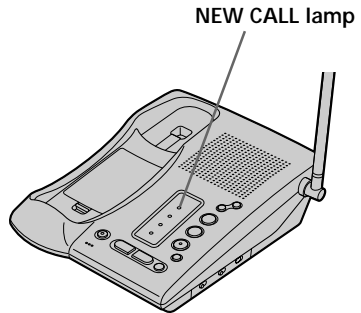

About the "*" mark

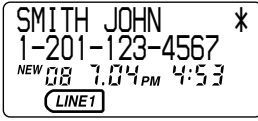

"*" appears if there are more than two calls from the same phone number. The older data will be replaced by the new data, so the calls are counted as only one call.

Erasing data from the Caller ID list

Old data will be erased automatically when a 21st call comes in, but you can also manually erase unnecessary data one by one or erase the entire list.

To erase the phone number one by one

- 1 Display the phone number you want to erase from the Caller ID list (see page 48).
- 2 Press Jog Dial.
- 3 Turn Jog Dial up to make "ERASE" flash and press Jog Dial.
- 4 Turn Jog Dial up to make "YES" flash, then press Jog Dial.
You will hear a long confirmation beep and the data is erased.

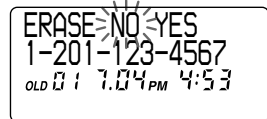
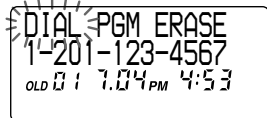
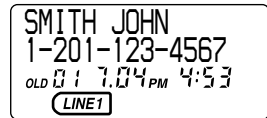

continued

Looking at the Caller ID list (continued)

To erase the entire list at once

1 Display any Caller ID data.

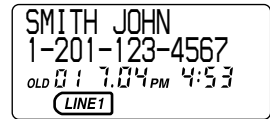

2 Press Jog Dial.

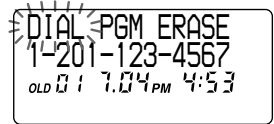

3 Turn Jog Dial up to make “ERASE” flash and press Jog Dial.

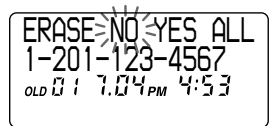

4 Turn Jog Dial up to make “ALL” flash, then press Jog Dial.

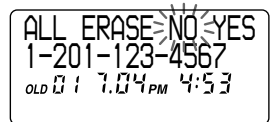

5 Turn Jog Dial up to make “YES” flash, then press Jog Dial.

You will hear a long confirmation beep and the entire list is erased.

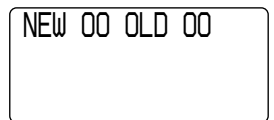

Note

“ALL” appears only when all the data has become “OLD” data. If there is any “NEW” data, you cannot erase the entire list.

Using the Caller ID list

By using the Caller ID list, you can call back a phone number from the Caller ID list easily, or store numbers from the Caller ID list into the Phone Directory.

Calling back a number from the Caller ID list

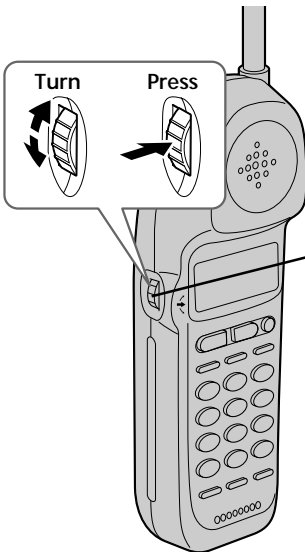

1 Display the phone number you want to call from the Caller ID list (see page 48).

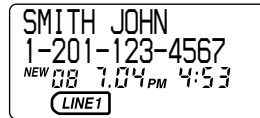

2 Confirm the number and press Jog Dial.

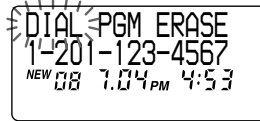

3 Press Jog Dial again.
The phone automatically dials the displayed number.

Notes

- If the number displayed in step 1 is not the one you should call back, you can change the number of digits of the phone number as described on page 53.
- If the phone is connected to a Private Branch Exchange (PBX), you may not be able to call back from the Caller ID list because an outside line access digit is necessary.
- When neither line is in use, line 1 is automatically connected in step 3. If you want to select the line manually, press **LINE1** or **LINE2** after step 1. You will then be connected to the line you have chosen.

Using the Caller ID list (continued)

Storing a number of the Caller ID list into the Phone Directory

- 1 Display the name and phone number you want to store from the Caller ID list (see page 48).

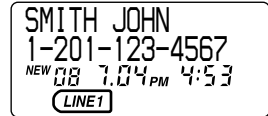

- 2 Confirm the number and press Jog Dial.

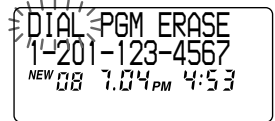

- 3 Turn Jog Dial up to make "PGM" flash and press Jog Dial.

The cursor flashes at the end of the name.

Enter or change the name, if necessary (see page 34).

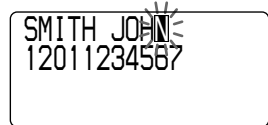

- 4 Press Jog Dial.

The cursor flashes at the end of the phone number.

Enter or change the phone number, if necessary (see page 34).

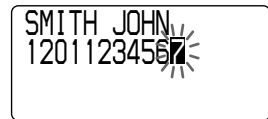

- 5 Press Jog Dial again.

You will hear a long confirmation beep and the name and number are stored.

Notes

- Do not allow more than 20 seconds to elapse between each step of the procedure.
- If the number displayed in step 1 is not the one you should store, you can change the number of digits of the phone number as described on page 53.
- If the phone is connected to a Private Branch Exchange (PBX), you may need to add an outside line access digit.

To change the number of digits of the phone number

If the number of digits of the phone number in the Caller ID list is different from the actual phone number, you need to adjust the number of digits of the phone number to call back or store into the PhoneDirectory .

- 1 While the phone number from the Caller ID list is displayed, press **(#)** repeatedly until the phone number with the correct number of digits appears on the display.

Each time you press **(#)**, the number of digits changes as follows:

When the home area code and the local area code do not match

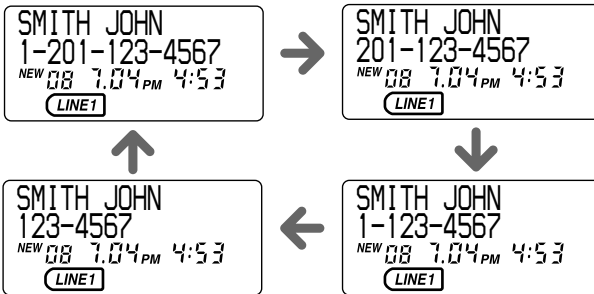

When the home area code matches

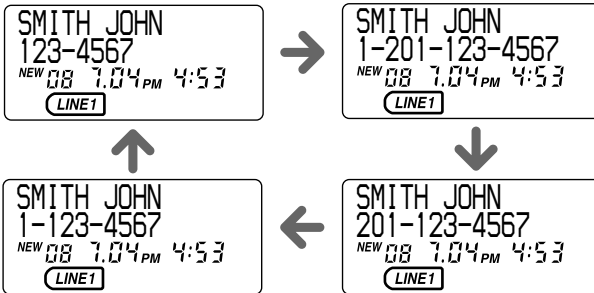

continued

Using the Caller ID list (continued)

When the local area code matches

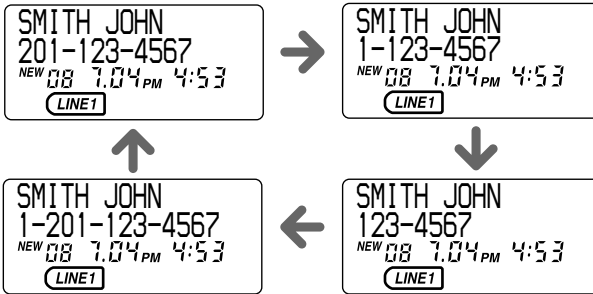

2 Continue the operation to call or store the phone number with the correct number of digits (pages 51 and 52).

Notes

- You need to adjust the number of digits each time you call back from the Caller ID list as the changes to the Caller ID data is not stored in memory.
- You may not be able to change the number of digits depending on the Caller ID data.

Using “Caller ID with call waiting” service

This telephone is compatible with the “Caller ID with call waiting” service. Make sure that your telephone company offers this service.

Like the basic Caller ID service, you need to subscribe to “Caller ID with call waiting” in order to use this service.

Even though you may have already subscribed to “Caller ID” and “call waiting” as two separate services, you need to request a subscription to “Caller ID with call waiting” as a single service.

This is a new service that combines the two services.

Even though you now have a “Caller ID with call waiting” compatible phone, unless you subscribe to the combined “Caller ID with call waiting” service, you will not be able to see the name and number of the second caller.

When a new call comes in while you are talking, you hear two short beeps. The caller’s name and/or phone number of the new call appears on the display for about 20 seconds.

To switch to another caller



- 1** To switch to the new caller, press **FLASH/CALL WAITING**.
(If you’re at the base unit, press **CALL WAITING/FLASH**.)
- 2** To switch back to the first caller, press **FLASH/CALL WAITING** (or **CALL WAITING/FLASH**) again.

Using visual message waiting service

If you subscribe to your telephone company's message service which includes this feature, the display will show that you have messages waiting to be retrieved.

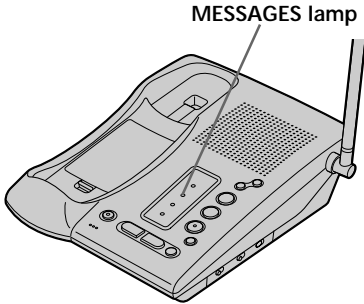

If you have messages

The MESSAGES lamp on the base unit flashes.

The MESSAGES lamp will go off when you retrieve your messages.

Note

You cannot use this feature, if you have not subscribed to your telephone company's message service.

For details on the availability of this service, please ask your telephone company.

If the MESSAGES lamp remains flashing

If this lamp does not go off (e.g. When you retrieve your messages with other phones), you can go off the lamp manually.

To go off the MESSAGES lamp

- 1 Press (PGM) on the handset.
- 2 Press (#) on the handset.
- 3 Press Jog Dial.

The MESSAGES lamp on the base unit goes off, and you will hear a long confirmation beep.



Using visual message waiting service (continued)

If you move or change your telephone company

Message waiting signals are sent in one of two ways: FSK signaling or “stutter” signaling (Your telephone company can provide you with more information about your service).

The first time this phone receives a voice mail message, it will set itself to the FSK service and will lock out the stutter service if your telephone company is in FSK service.

When you move or change your telephone company, you need to perform the following procedure. The phone will return to ready state for either FSK or stutter dial tone voice mail recognition.

To reset this phone

- 1 Press **(PGM)** on the handset.
- 2 Press **(#)** on the handset.
- 3 Turn Jog Dial up to make “RESET” flash and press Jog Dial.
You will hear a long confirmation beep and the phone is reset.



Mounting the base unit on a wall

1



1

Raise the hang-up tab.

2

Plug the telephone line cord(s) to the L1/L1+L2, and/or L2, DATA jack(s) and the AC power adaptor to the DC IN 9V jack, and hook the cords.

2

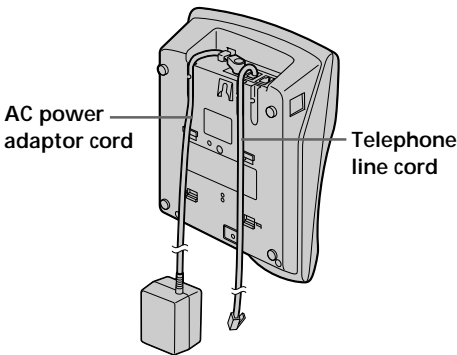

3

Attach the wall bracket to the center of the base unit.

Align the Δ marks of the wall bracket with those of the base unit.

3

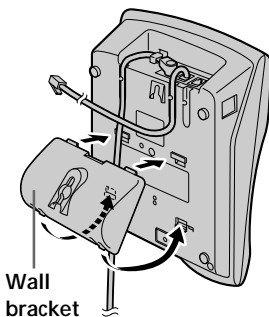

4

Plug the telephone line cord(s) to the telephone outlet(s), and hook the base unit to the wall plate.

5

Plug the AC power adaptor to an AC outlet. Then raise the antenna so that it points towards the ceiling.

4,5

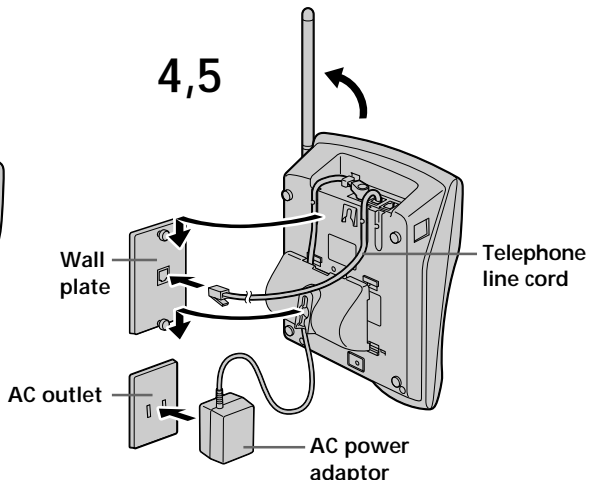

Tip

To remove the wall bracket, press the lower tabs.

Carrying the handset by the belt clip

You can hang the handset on the belt by attaching the belt clip to the handset.

Attaching the belt clip

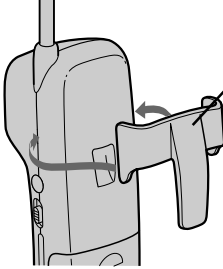

Press the belt clip to the handset. Make sure that the side tabs click and go into the holes on the sides of the handset.

Note

To prevent the handset from dropping, make sure that each tab is completely inserted.

Detaching the belt clip

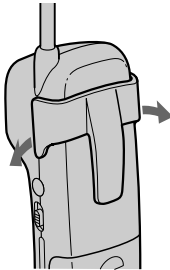

While pressing the back of the belt clip, pull the sides one by one until the tabs come off from the holes.

Note

Remove the belt clip carefully to avoid breaking your fingernails.

Using the headset

You can talk on handset without using your hands by connecting Sony TL-HD1 headset (optional) to the  (HEADSET) jack on the handset.

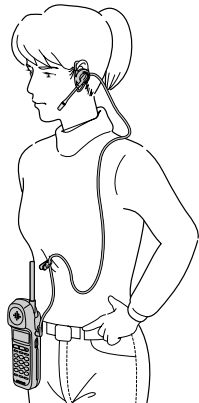

Notes on power sources

On battery pack

- Store the battery pack at a temperature between 41°F (5°C) and 95°F (35°C) for best performance.
- If you do not use the handset for a long period of time, remove the battery pack from the handset after charging for more than 12 hours, and base unit after charging for more than 24 hours when you have a spare battery. This maintains battery life.

On power failure

During a power interruption, you cannot make or receive calls.

For the customers in the USA

RECYCLING NICKEL-CADMIUM BATTERIES

Nickel-Cadmium batteries are recyclable. You can help preserve our environment by returning your unwanted batteries to your nearest point for collection, recycling or proper disposal.



Note: In some areas the disposal of nickel-cadmium batteries in household or business trash may be prohibited.

RBRC (Rechargeable Battery Recycling Corporation) advises you about spent battery collection by the following phone number.

Call toll free number: 1-800-822-8837
(United States and Canada only)

Caution: Do not handle damaged or leaking nickel-cadmium batteries.

Maintenance



- Clean the cabinets with a soft cloth slightly moistened with water or a mild detergent solution. Do not use any type of abrasive pad, scouring powder or solvent such as alcohol or benzine as they may damage the finish of the cabinet.
- If the charge terminals of the base unit and handset are soiled, wipe them with a soft cloth.

If you have any questions or problems concerning your phone, please consult your nearest Sony dealer.

Troubleshooting

If you've experienced any of the following difficulties while using your phone, use this troubleshooting guide to help you remedy the problem. Should any problem persist, consult your nearest Sony dealer.

	Symptom	Remedy
Making calls	You hear five short error beeps when you press (LINE 1) or (LINE 2) .	<ul style="list-style-type: none"> • Make sure you have set up the base unit correctly (page 10). • Move the handset closer to the base unit.
	You hear no dial tone.	<ul style="list-style-type: none"> • Make sure the telephone line cord is securely connected to the telephone outlet. • Make sure the battery is fully charged (page 14).
	The phone does not connect at all, even though the number you dial is correct.	<ul style="list-style-type: none"> • Make sure the dialing mode is set correctly (page 13).
	The phone does not redial correctly.	<ul style="list-style-type: none"> • Make sure the last dialed number is really the one you want to dial.
	You hear five short error beeps when you try to redial.	<ul style="list-style-type: none"> • The number you last dialed exceeds 32 digits (including the tone and pause digits if used). • The number you last dialed is erased.
Receiving calls	You cannot perform the redial operations (redialing, checking and erasing the phone number), and "CHANNEL SEARCHING..." appears on the display.	<ul style="list-style-type: none"> • Move the handset closer to the base unit and perform the redial operations again.
	The handset does not ring.	<ul style="list-style-type: none"> • Make sure the ringer is turned on (page 38). • The battery may be weak. Charge the battery for more than 12 hours (page 14). • Make sure you have set up the base unit correctly (page 10). • Move the handset closer to the base unit.
	The base unit does not ring.	<ul style="list-style-type: none"> • Set the L1 or L2 RINGER LEVEL switch on the base unit to HIGH or LOW. • Make sure the telephone line cord is securely connected to the telephone outlet.

	Symptom	Remedy
During conversation	You hear interference during conversation.	<ul style="list-style-type: none"> • Move the handset closer to the base unit. • Place the base unit away from noise sources (page 10).
	Your conversation is muted and “CHANNEL SEARCHING...” appears on the display.	<ul style="list-style-type: none"> • This is the out-of-range alarm. Move the handset closer to the base unit within one minute.
	You hear a beep every three seconds and  and “BATTERY LOW” appear on the display.	<ul style="list-style-type: none"> • The battery is weak. Charge the battery for more than 12 hours (page 14).
LINE 1 and 2 buttons	LINE 1 or 2 button flashes when not in use.	<ul style="list-style-type: none"> • Either the handset or the base unit is being used.
Phone Directory	You hear five short error beeps and cannot store a number in the Phone Directory.	<ul style="list-style-type: none"> • Make sure you follow the procedure for storing the number correctly (pages 32). • Make sure the number (including the tone and pause digits) does not exceed 32 digits.
	Phone Directory dialing is incorrect.	<ul style="list-style-type: none"> • Store the correct number (pages 32).
Intercom	The handset does not ring when you use the intercom from the base unit, and the base unit does not ring when you use the intercom from the handset.	<ul style="list-style-type: none"> • The battery may be weak. Charge the battery for more than 12 hours (page 14). • Move the handset closer to the base unit. • Place the base unit away from noise sources (page 10).
	When pressing  , you hear a busy tone and cannot make an intercom call.	<ul style="list-style-type: none"> • Either the base unit or handset is being used to converse with an outside caller.

continued

Troubleshooting (continued)

	Symptom	Remedy
Caller ID	The caller's name and/or phone number does not appear on the display.	<ul style="list-style-type: none"> • Make sure you have subscribed to Caller ID service. • Caller ID service may not work when the phone is connected to a Private Branch Exchange (PBX). • The call is made through company which does not offer Caller ID service. "OUT OF AREA" will appear on the display. • The call was "blocked". "PRIVATE" will appear on the display. • You have answered the call while "** RINGING **" was displayed. Be sure to answer after the Caller ID data is displayed.
	The caller's name and/or phone number does not appear on the display during call waiting.	<ul style="list-style-type: none"> • Make sure you have subscribed to "Caller ID with call waiting" service (page 55). • Make sure nobody is talking with another phone on the same telephone line.
	You cannot dial the number from the Caller ID list.	<ul style="list-style-type: none"> • Make sure you entered your home area code correctly (page 17). • You may need to change the number of digits of the phone number (page 53). • This function may not work when the phone is connected to a Private Branch Exchange (PBX).
	The memory match function does not work.	<ul style="list-style-type: none"> • If the call is from an office which uses multiple lines, the phone number may not match the number you put in the memory. • If you have stored the phone number with an outside line access digit in the Phone Directory because the phone is connected to a Private Branch Exchange (PBX), the phone number will not match the Caller ID data.
	You cannot use visual message waiting service.	<ul style="list-style-type: none"> • Make sure you have subscribed to visual message waiting service (page 56). • If you move or change your telephone company, reset this phone (page 57).
Power source/battery	The CHARGE lamp does not light up when you place the handset to charge.	<ul style="list-style-type: none"> • Wipe the charge terminals of the base unit and the handset with a soft cloth for better contact of the charge terminals. • Make sure the handset is placed on the base unit properly.
	The battery duration is short.	<ul style="list-style-type: none"> • The battery pack was charged less than 12 hours (due to power failure, etc.). • The usage life of the battery has expired and needs replacement.
	The CHARGE lamp flashes.	<ul style="list-style-type: none"> • Move the handset closer to the base unit. • Make sure the battery is inserted in the handset. • The battery may be completely discharged. Charge the battery for more than 12 hours (page 14). It may require several times of charging to recover to its full capacity.

Specifications

General

- Frequency band
902 - 928 MHz
- Operating channel
30 channels
- Dial signal
Tone, 10 PPS (pulse) selectable
- Supplied accessories
See page 9.

Handset

- Power source
Rechargeable battery pack BP-T23
- Battery charging time
Approx. 12 hours
- Battery life
Standby: Approx. 7 days
Talk: Approx. 7 hours
- Dimensions
Approx. 2 ¼ x 7 ½ x 1 15/16 inches (w/h/d),
antenna excluded
(approx. 57 x 190 x 48 mm)
Antenna: Approx. 3 ½ inches
(approx. 87 mm)
- Mass
Approx. 9.5 oz
(approx. 268 g), battery included

Base unit

- Power source
DC 9V from AC power adaptor
AC-T128
- Battery charging time
Approx. 24 hours
- Dimensions
Approx. 6 ¾ x 2 ¾ x 8 ¾ inches (w/h/d),
antenna excluded
(approx. 171 x 68 x 221 mm)
Antenna: Approx. 6 inches
(approx. 150 mm)
- Mass
Approx. 1 lb 5 oz
(approx. 582 g), wall bracket excluded

Design and specifications are subject to change without notice.

Index

A

- Adjusting volume
 - handset volume 25, 29
 - speaker volume 30
- Area code 17

B

- Battery pack
 - charging 14
 - duration 15

C

- Call waiting service 25, 55
- Caller ID 47
 - Caller ID list 48
 - calling back 51
 - memory match function 47
 - storing in Phone Directory 52
- Caller ID with call waiting 55
- Carrying the handset by the belt clip 59
- Conference 44
- Connection 11

D

- Dialing mode
 - choosing 13
 - switching to the tone temporarily 25
- Directory
 - Phone Directory 32

E, F, G

- Erasing
 - Caller ID data 49
 - last phone number dialed 26
 - local area code 19
 - Phone Directory 35

H

- Headset 24, 28, 59
- Hold 25, 29
- Home area code 17

I, J, K

- Identifying the parts 20
- Intercom 40

L

- Local area code 18
- Location, base unit 10

M, N

- Making calls 24
- Memory match function 47
- Mounting the base unit on a wall 58
- Muting 30

O

- OUT OF AREA 47

P, Q

- Package contents 9
- Phone Directory 32
- PRIVATE 47
- Pulse dialing 13

R

- Receiving calls 28
- Redialing 26
- Ringer
 - L1/L2 RINGER LEVEL switch 30
 - setting the ringer type 37
 - turning on/off 38

S

- Setting up
 - base unit 10
 - handset 14
- Spare battery 16
- Speakerphone 29, 30
- Storing Caller ID data in Phone Directory 52
- Switching phones during a call 39

T, U

- Talking between the phones 40
- Three-way conference 44
- Tone dialing
 - dialing mode 13
 - switching to 25
- Transferring a call 42
- Troubleshooting 62

V, W, X, Y, Z

- Visual message waiting service 56
- Volume
 - handset 25, 29
 - speaker 30

For the customers in the USA

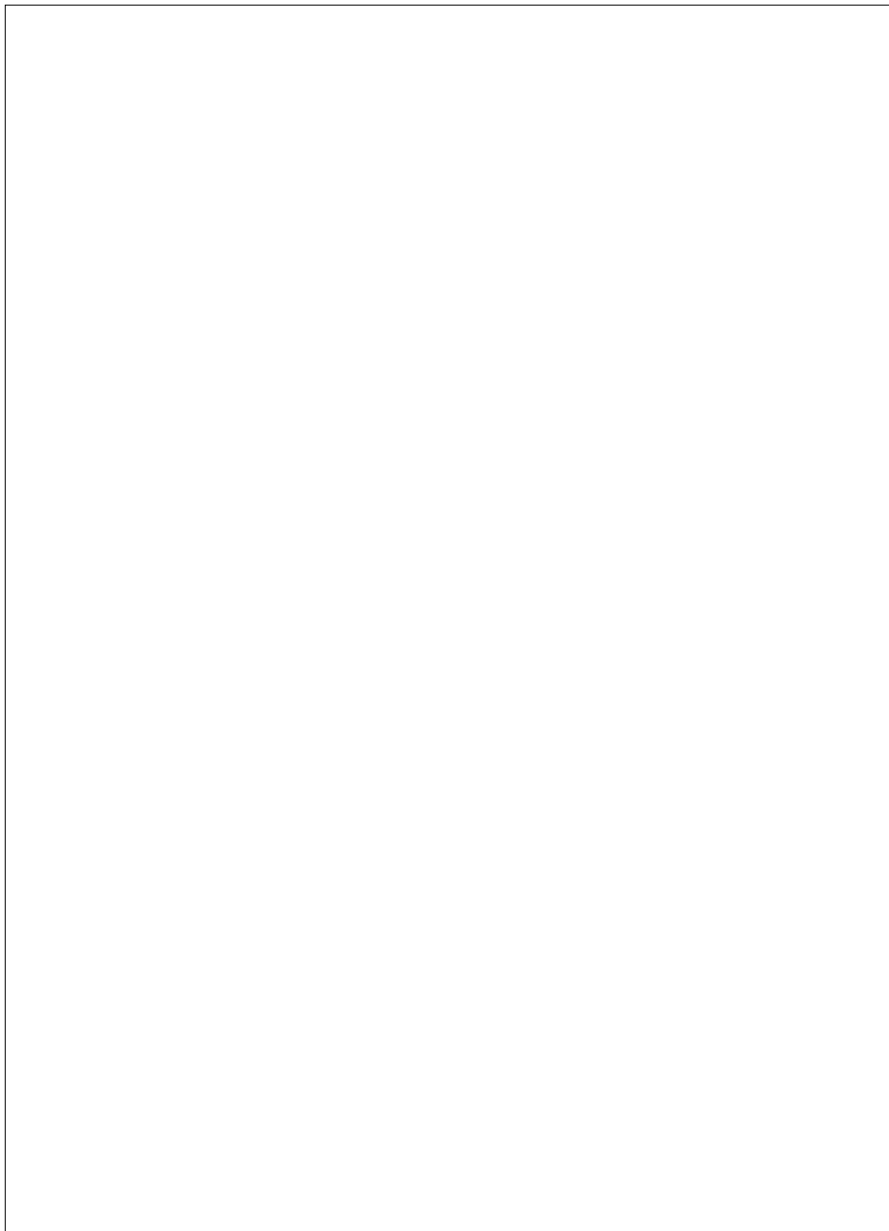

Be sure to save the receipt and attach it to your WARRANTY card when having your equipment repaired at an authorized Sony service station.